

**Specifications**

Nominal Voltage		6 V
Capacity (25°C)	20HR(5.25V)	5Ah
	10HR(5.25V)	4.7Ah
	1HR(4.80V)	3.25Ah
Dimension	Length	70 ± 1mm (2.76inch)
	Width	47 ± 1mm (1.85inch)
	Height	101 ± 1mm (3.98inch)
	Total Height	107 ± 1mm (4.21inch)
Approx. Weight		0.80kg (1.76lbs) ± 5%
Terminal type		T1
Internal resistance (Fully charged, 25°C)		Approx. 15mΩ
Capacity affected by temperature (20HR)	40°C	102%
	25°C	100%
	0°C	85%
	-15°C	65%
Self-discharge (25°C)	3 month	Remaining Capacity: 91%
	6 month	Remaining Capacity: 82%
	12 month	Remaining Capacity: 65%
Nominal operating temperature		25°C ± 3°C (77°F ± 5°F)
Operating temperature range	Discharge	-15°C ~ 50°C (5°F ~ 122°F)
	Charge	-10°C ~ 50°C (14°F ~ 122°F)
	Storage	-20°C ~ 50°C (-4°F ~ 122°F)
Float charging voltage(25°C)		6.80 to 6.90V Temperature compensation: -9mV/°C
Cyclic charging voltage(25°C)		7.25 to 7.45V Temperature compensation: -15mV/°C
Maximum charging current		1.5A
Terminal material		Copper
Maximum discharge current		75A(5 sec.)
Designed floating life(20°C)		10years

- ◆ Absorbent glass mat technology;
- ◆ Recognized by UL & CE;
- ◆ ABS container.

**Dimensions**

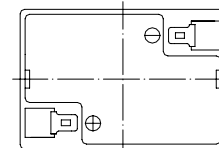
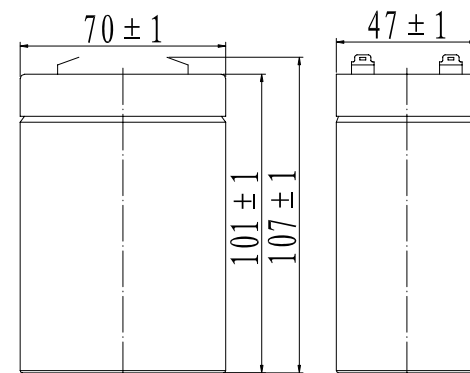

**Terminal**

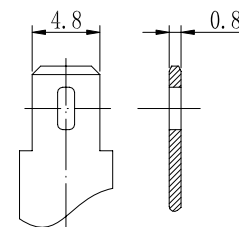

Terminal T1

**Constant Current Discharge Characteristics (A, 25°C)**

F.V/TIME	5min	10min	15min	30min	60min	2h	3h	4h	5h	10h	20h
4.80V	19.0	12.0	9.50	5.30	3.25	1.78	1.28	1.02	0.87	0.47	0.26
4.95V	18.4	11.6	9.27	5.19	3.20	1.77	1.27	1.01	0.86	0.47	0.25
5.10V	17.7	11.2	8.93	5.04	3.12	1.75	1.26	1.01	0.86	0.47	0.25
5.25V	16.9	10.7	8.63	4.91	3.06	1.72	1.25	1.00	0.85	0.47	0.25
5.40V	16.0	10.1	8.17	4.73	2.96	1.68	1.21	0.97	0.82	0.46	0.25

**Constant Power Discharge Characteristics (Watt, 25°C)**

F.V/TIME	5min	10min	15min	30min	60min	2h	3h	4h	5h	10h	20h
4.80V	106	67.7	54.2	30.4	18.8	10.4	7.57	6.07	5.18	2.83	1.52
4.95V	103	65.6	52.9	29.8	18.5	10.3	7.53	6.04	5.15	2.82	1.52
5.10V	98.6	62.9	50.9	28.9	18.1	10.2	7.48	6.00	5.11	2.81	1.51
5.25V	94.4	60.2	49.2	28.2	17.7	10.1	7.43	5.96	5.07	2.79	1.50
5.40V	89.1	56.9	46.6	27.1	17.2	9.83	7.20	5.78	4.92	2.73	1.47

Note: The above characteristics data can be obtained within three charge/discharge cycles.

**Discharge Characteristics(25°C)**

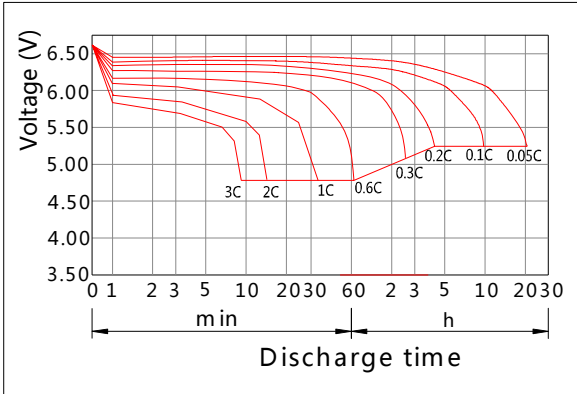

**Charging Characteristics(25°C)**

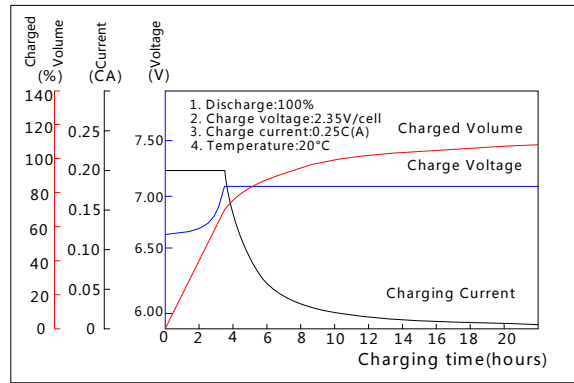

**Effect of Temperature on Capacity**

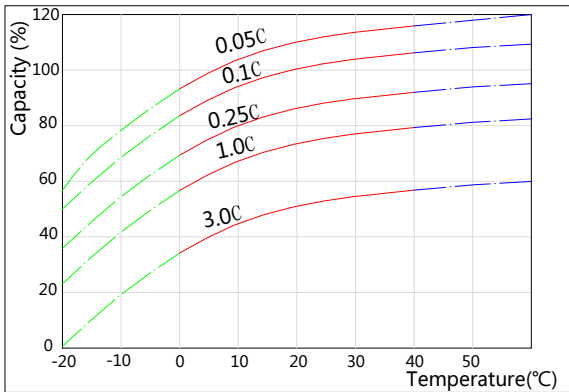

**Self-discharge Characteristics**

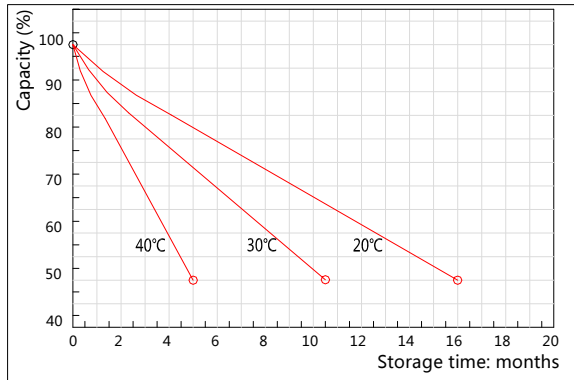

**The Relationship for Open Circuit Voltage and Residual Capacity (25°C)**

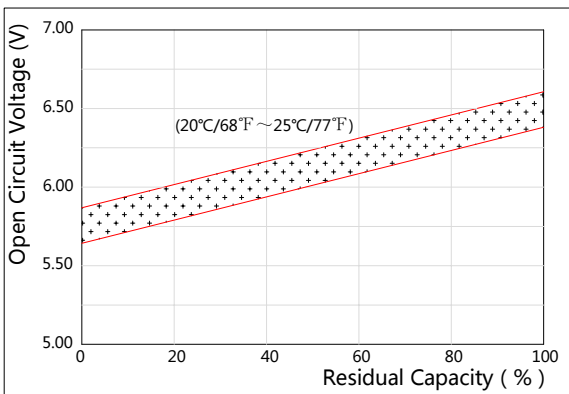

**The Relationship for Charging Voltage and Temperature**

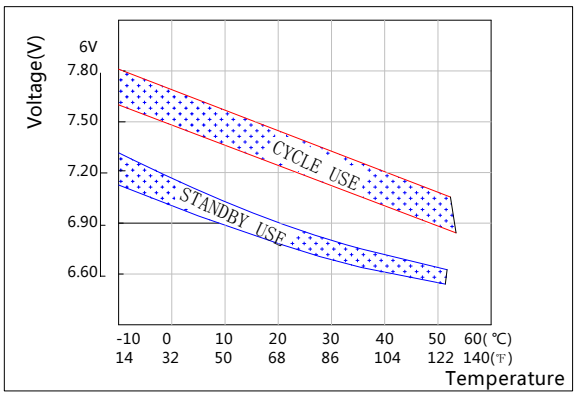

**Floating Life on Temperature**

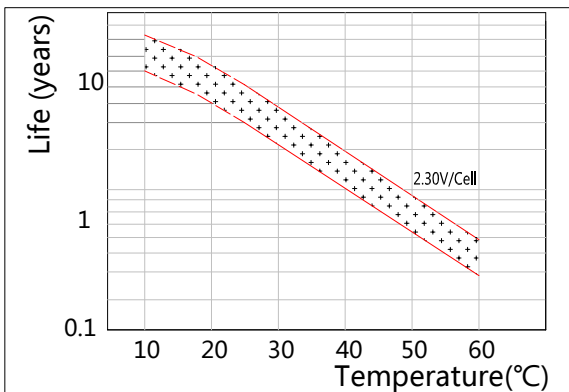

**Cycle Life on D.O.D(25°C)**

