

Standard Series FP445 4V4.5Ah

FirstPower®

Dimension(mm)

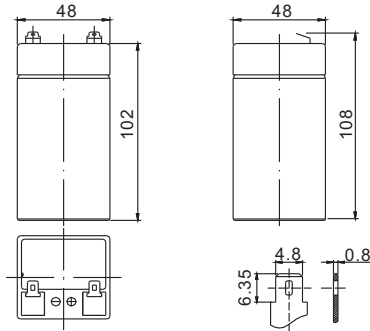

T1
Terminal



Specification

Nominal Voltage		4 V
Capacity(20HR, 25°C)		4.5 Ah
Dimension	Length	48mm (1.89inch)
	Width	48mm (1.89inch)
	Height	102mm (4.02inch)
	Total Height	108mm (4.25inch)
Approx. Weight		0.50kg (1.10lbs)

Characteristics

Capacity 20°C (68□) To 1.70V/Cell	20 hour rate	4.5Ah
	10 hour rate	4.5Ah
	5 hour rate	3.75Ah
	1 hour rate	3.02Ah
	15 min rate	2.11Ah
Internal resistance(Fully charged, 25°C)		Approx. 15mΩ
Capacity affected by temperature (20HR)	40°C	102%
	25°C	100%
	0°C	85%
	-15°C	65%
Self-discharge (25°C)	3 month	Remaining Capacity: 91%
	6 month	Remaining Capacity: 82%
	12 month	Remaining Capacity: 65%
Nominal operating temperature		25°C ±3°C(77°F ±5°F)
Operating temperature range		-15°C~50°C(5°F~122°F)
Float charging voltage(25°C)		4.50 to 4.60V
Cyclic charging voltage(25°C)		4.85 to 4.95V
Maximum charging current		1.35A
Terminal material		Copper
Maximum discharge current		68A(5 Sec.)

The Relationship for Open Circuit Voltage and Residual Capacity (25°C)

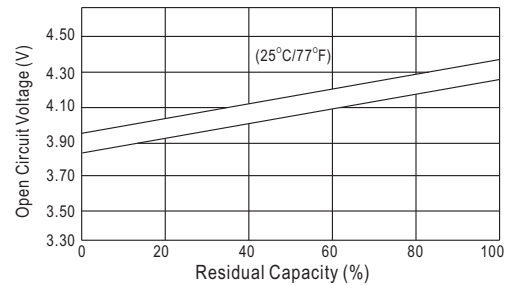

Charging Characteristics(25°C)

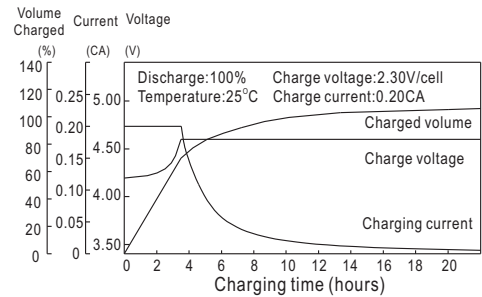

Cycle Life(25°C)

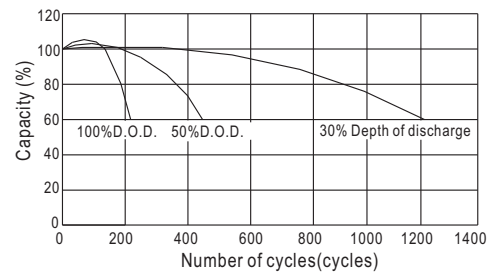

Constant Current Discharge Characteristics (A, 25°C)

F.V/TIME	5min	10min	15min	30min	60min	3h	5h	10h	20h
3.20V	16.2	10.8	8.80	4.80	3.10	1.12	0.76	0.45	0.23
3.40V	15.4	10.3	8.45	4.65	3.02	1.10	0.75	0.45	0.23
3.60V	14.5	9.65	8.03	4.47	2.92	1.06	0.74	0.44	0.22

Constant Power Discharge Characteristics (Watt, 25°C)

5min	10min	15min	30min	60min	3h	5h	10h	20h
60.3	40.6	33.4	18.3	12.0	4.44	3.02	1.80	0.92
57.3	38.7	32.1	17.8	11.7	4.36	2.99	1.80	0.92
53.9	36.3	30.5	17.1	11.3	4.20	2.95	1.76	0.88