

**Specifications**

|                                           |              |                                                       |
|-------------------------------------------|--------------|-------------------------------------------------------|
| Nominal Voltage                           |              | 12 V                                                  |
| Capacity (25°C)                           | 20HR(10.5V)  | 4.5Ah                                                 |
|                                           | 10HR(10.5V)  | 4.2Ah                                                 |
|                                           | 1HR(9.60V)   | 2.93Ah                                                |
| Dimension                                 | Length       | 90 ± 1mm (3.54inch)                                   |
|                                           | Width        | 70 ± 1mm (2.76inch)                                   |
|                                           | Height       | 101 ± 1mm (3.98inch)                                  |
|                                           | Total Height | 107 ± 1mm (4.21inch)                                  |
| Approx. Weight                            |              | 1.47kg (3.24lbs) ± 5%                                 |
| Terminal type                             |              | T1/T2                                                 |
| Internal resistance (Fully charged, 25°C) |              | Approx. 45mΩ                                          |
| Capacity affected by temperature (20HR)   | 40°C         | 102%                                                  |
|                                           | 25°C         | 100%                                                  |
|                                           | 0°C          | 85%                                                   |
|                                           | -15°C        | 65%                                                   |
| Self-discharge (25°C)                     | 3 month      | Remaining Capacity: 91%                               |
|                                           | 6 month      | Remaining Capacity: 82%                               |
|                                           | 12 month     | Remaining Capacity: 65%                               |
| Nominal operating temperature             |              | 25°C ± 3°C (77°F ± 5°F)                               |
| Operating temperature range               | Discharge    | -15°C ~ 50°C (5°F ~ 122°F)                            |
|                                           | Charge       | -10°C ~ 50°C (14°F ~ 122°F)                           |
|                                           | Storage      | -20°C ~ 50°C (-4°F ~ 122°F)                           |
| Float charging voltage(25°C)              |              | 13.60 to 13.80V<br>Temperature compensation: -18mV/°C |
| Cyclic charging voltage(25°C)             |              | 14.50 to 14.90V<br>Temperature compensation: -30mV/°C |
| Maximum charging current                  |              | 1.35A                                                 |
| Terminal material                         |              | Copper                                                |
| Maximum discharge current                 |              | 67.5A(5 sec.)                                         |
| Designed floating life(20°C)              |              | 3~5 years                                             |

- ◆ Absorbent glass mat technology;
- ◆ Recognized by UL & CE;
- ◆ ABS container.

**Constant Current Discharge Characteristics (A, 25°C)**

| F.V/TIME | 5min | 10min | 15min | 30min | 60min | 2h   | 3h   | 4h   | 5h   | 10h  | 20h   |
|----------|------|-------|-------|-------|-------|------|------|------|------|------|-------|
| 9.60V    | 17.1 | 10.8  | 8.55  | 4.77  | 2.93  | 1.60 | 1.15 | 0.92 | 0.78 | 0.42 | 0.228 |
| 9.90V    | 16.6 | 10.5  | 8.34  | 4.67  | 2.88  | 1.59 | 1.14 | 0.91 | 0.78 | 0.42 | 0.227 |
| 10.2V    | 15.9 | 10.0  | 8.04  | 4.53  | 2.81  | 1.58 | 1.13 | 0.91 | 0.77 | 0.42 | 0.226 |
| 10.5V    | 15.2 | 9.61  | 7.76  | 4.42  | 2.75  | 1.55 | 1.13 | 0.90 | 0.77 | 0.42 | 0.225 |
| 10.8V    | 14.4 | 9.07  | 7.35  | 4.26  | 2.67  | 1.51 | 1.09 | 0.87 | 0.74 | 0.41 | 0.221 |

**Constant Power Discharge Characteristics (Watt, 25°C)**

| F.V/TIME | 5min | 10min | 15min | 30min | 60min | 2h   | 3h   | 4h   | 5h   | 10h  | 20h  |
|----------|------|-------|-------|-------|-------|------|------|------|------|------|------|
| 9.60V    | 191  | 122   | 97.5  | 54.7  | 33.9  | 18.7 | 13.6 | 10.9 | 9.32 | 5.10 | 2.74 |
| 9.90V    | 185  | 118   | 95.1  | 53.6  | 33.4  | 18.6 | 13.6 | 10.9 | 9.26 | 5.08 | 2.73 |
| 10.2V    | 177  | 113   | 91.6  | 51.9  | 32.5  | 18.4 | 13.5 | 10.8 | 9.20 | 5.05 | 2.72 |
| 10.5V    | 170  | 108   | 88.5  | 50.7  | 31.9  | 18.2 | 13.4 | 10.7 | 9.13 | 5.02 | 2.70 |
| 10.8V    | 160  | 102   | 83.8  | 48.8  | 30.9  | 17.7 | 13.0 | 10.4 | 8.86 | 4.92 | 2.65 |

Note: The above characteristics data can be obtained within three charge/discharge cycles.

**Dimensions**

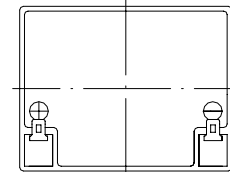
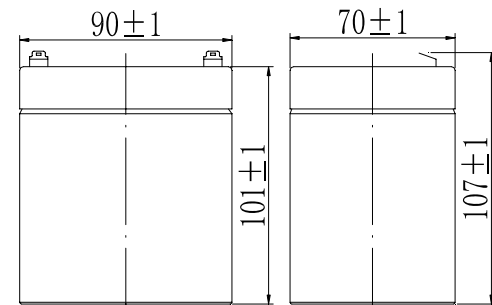

**Terminal**

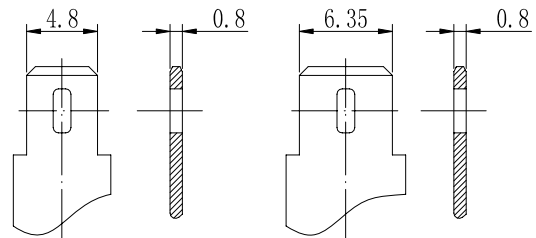

Terminal T1

Terminal T2

Discharge Characteristics(25°C)

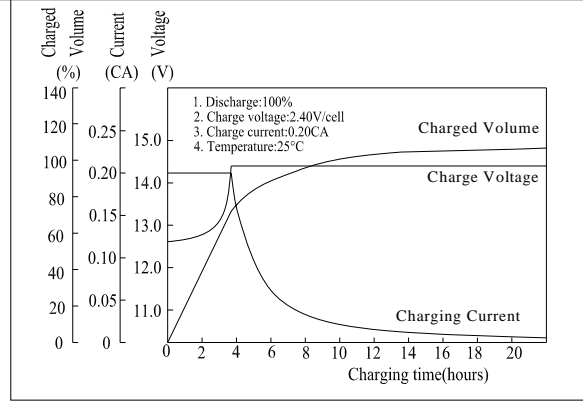
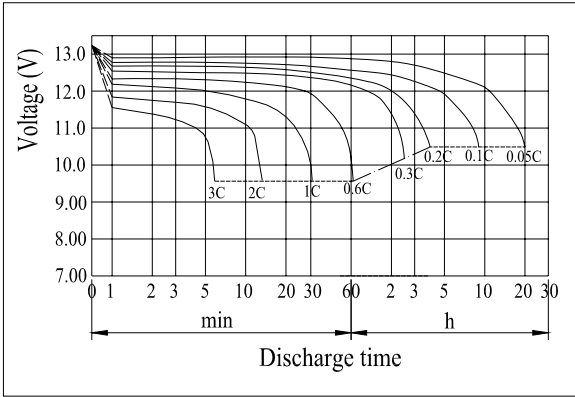

Effect of Temperature on Capacity

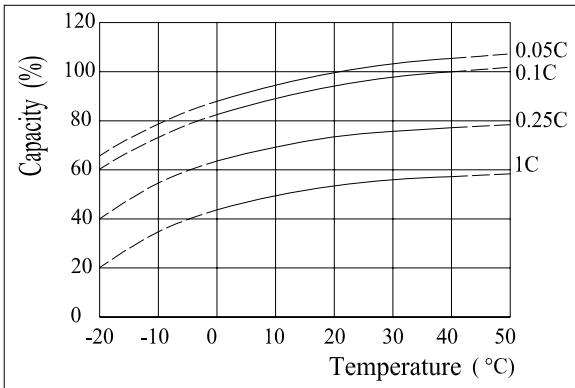

Self-discharge Characteristics

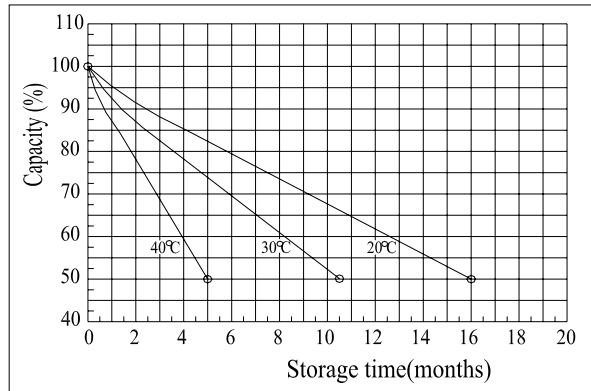

The Relationship for Open Circuit Voltage and Residual Capacity (25°C)

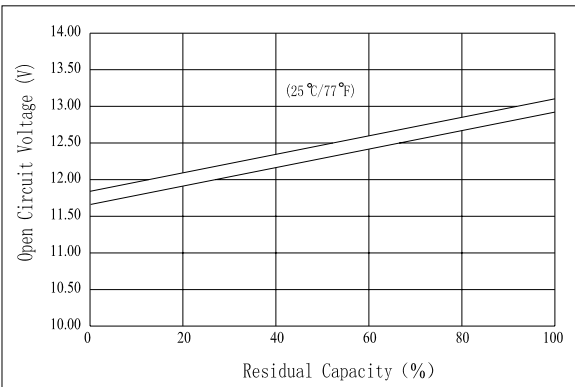

The Relationship for Charging Voltage and Temperature

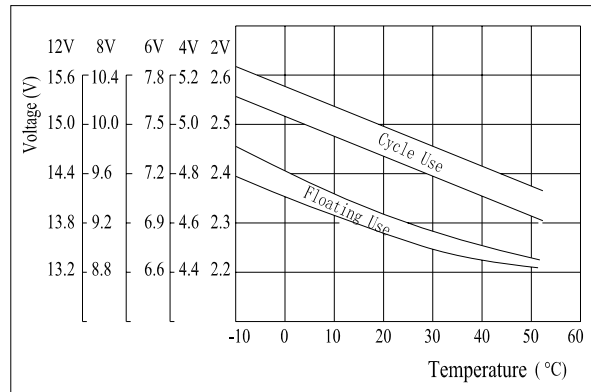

Floating Life on Temperature

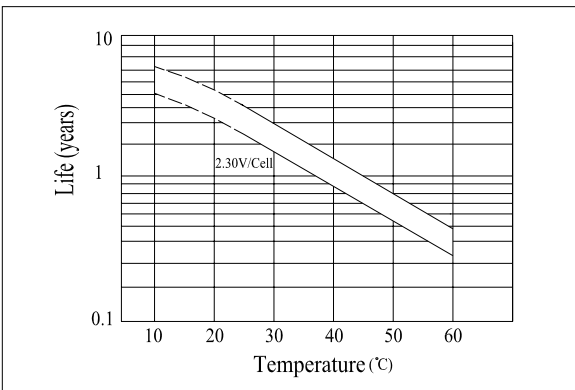

Cycle Life on D.O.D(25°C)

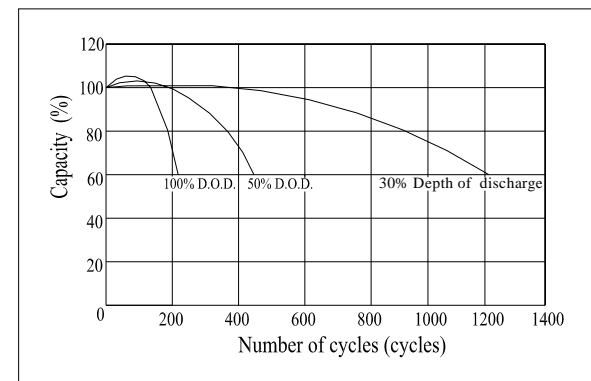

Charging Characteristics(25°C)