

Specifications

Nominal Voltage		12 V
Capacity (25°C)	20HR(10.5V)	2Ah
	10HR(10.5V)	1.9Ah
	1HR(9.60V)	1.3Ah
Dimension	Length	182 ± 1mm (7.17inch)
	Width	24 ± 0.5mm (0.94inch)
	Height	61 ± 1mm (2.40inch)
	Total Height	61 ± 1mm (2.40inch)
Approx. Weight		0.72kg (1.59lbs) ± 5%
Terminal type		Tab
Internal resistance (Fully charged, 25°C)		Approx. 130mΩ
Capacity affected by temperature (20HR)	40°C	102%
	25°C	100%
	0°C	85%
	-15°C	65%
Self-discharge (25°C)	3 month	Remaining Capacity: 91%
	6 month	Remaining Capacity: 82%
	12 month	Remaining Capacity: 65%
Nominal operating temperature		25°C ± 3°C (77°F ± 5°F)
Operating temperature range	Discharge	-15°C ~ 50°C (5°F ~ 122°F)
	Charge	-10°C ~ 50°C (14°F ~ 122°F)
	Storage	-20°C ~ 50°C (-4°F ~ 122°F)
Float charging voltage(25°C)		13.60 to 13.80V Temperature compensation: -18mV/°C
Cyclic charging voltage(25°C)		14.50 to 14.90V Temperature compensation: -30mV/°C
Maximum charging current		0.69A
Terminal material		Copper
Maximum discharge current		11.5A(5 sec.)
Designed floating life(20°C)		3~5 years

Dimensions

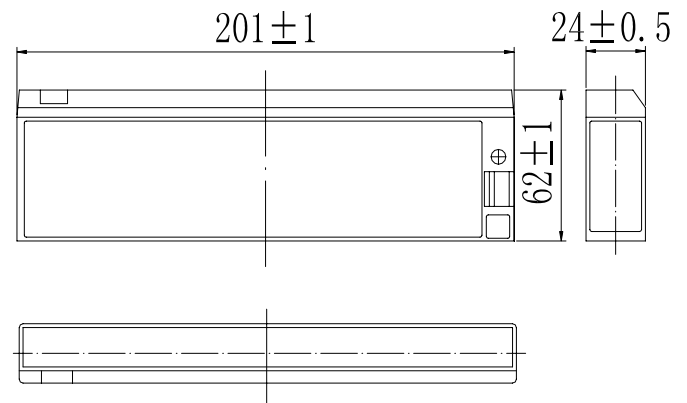

- ◆ Absorbent glass mat technology;
- ◆ Recognized by UL & CE;
- ◆ ABS container.

Constant Current Discharge Characteristics (A, 25°C)

F.V/TIME	10min	15min	30min	60min	2h	3h	4h	5h	8h	10h	20h
9.60V	4.80	3.80	2.12	1.30	0.71	0.51	0.41	0.35	0.22	0.19	0.10
9.90V	4.66	3.71	2.08	1.28	0.71	0.51	0.41	0.34	0.22	0.19	0.10
10.2V	4.46	3.57	2.01	1.25	0.70	0.50	0.40	0.34	0.22	0.19	0.10
10.5V	4.27	3.45	1.97	1.22	0.69	0.50	0.40	0.34	0.22	0.19	0.10
10.8V	4.03	3.27	1.89	1.19	0.67	0.49	0.39	0.33	0.21	0.18	0.10

Constant Power Discharge Characteristics (Watt, 25°C)

F.V/TIME	10min	15min	30min	60min	2h	3h	4h	5h	8h	10h	20h
9.60V	54.1	43.3	24.3	15.1	8.31	6.06	4.86	4.14	2.69	2.27	1.22
9.90V	52.5	42.3	23.8	14.8	8.26	6.02	4.83	4.12	2.68	2.26	1.21
10.2V	50.4	40.7	23.1	14.5	8.19	5.98	4.80	4.09	2.66	2.25	1.21
10.5V	48.2	39.3	22.5	14.2	8.07	5.94	4.76	4.06	2.64	2.23	1.20
10.8V	45.5	37.3	21.7	13.7	7.86	5.76	4.62	3.94	2.56	2.19	1.18

Note: The above characteristics data can be obtained within three charge/discharge cycles.

Discharge Characteristics(25°C)

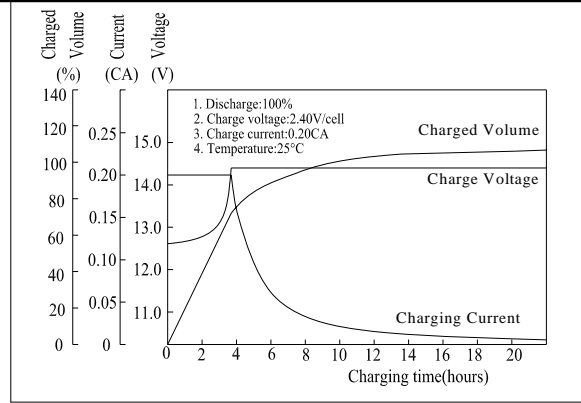
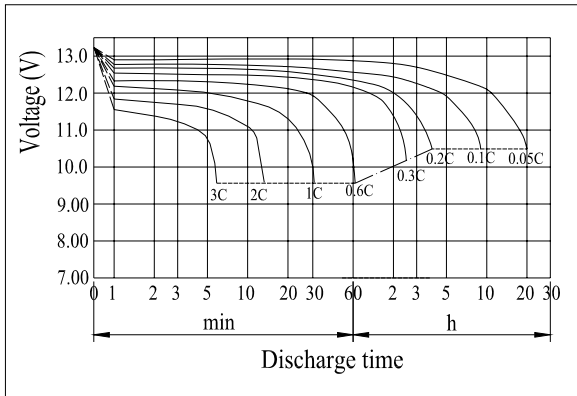

Effect of Temperature on Capacity

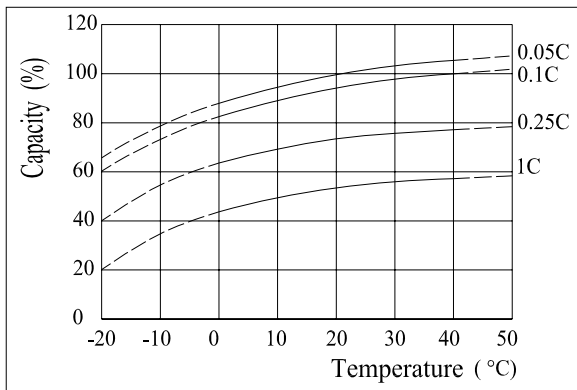

Self-discharge Characteristics

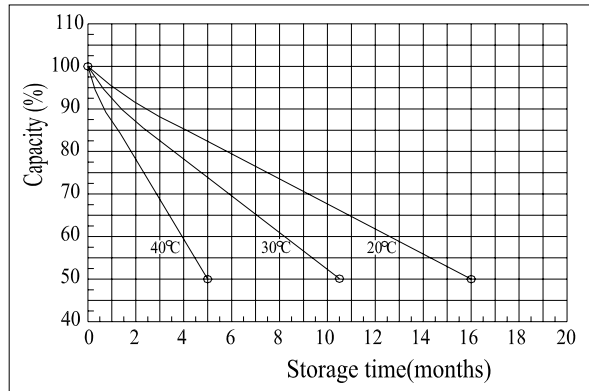

The Relationship for Open Circuit Voltage and Residual Capacity (25°C)

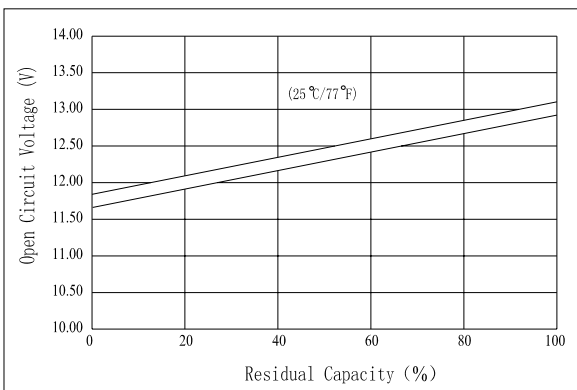

The Relationship for Charging Voltage and Temperature



Floating Life on Temperature

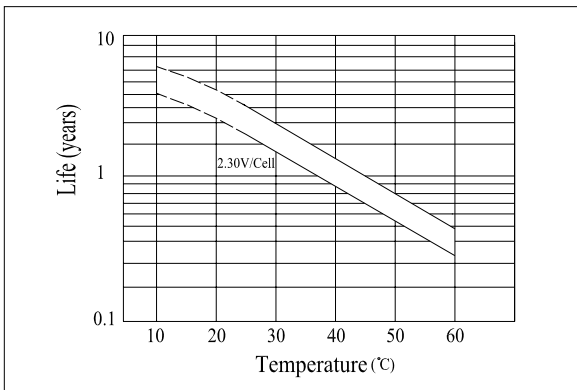

Cycle Life on D.O.D(25°C)

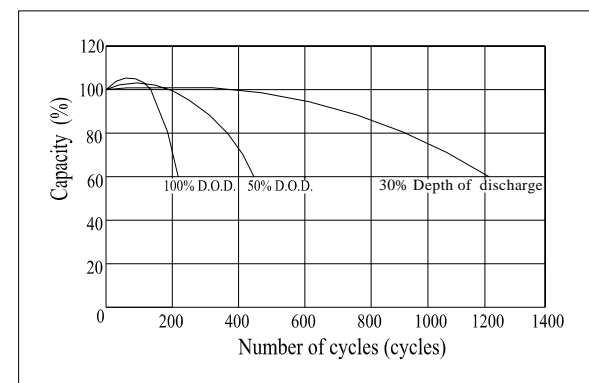

Charging Characteristics(25°C)