

Specifications

Nominal Voltage		12 V
Capacity (25°C)	20HR(10.5V)	2.3Ah
	10HR(10.5V)	2.1Ah
	1HR(9.60V)	1.5Ah
Dimension	Length	178 ± 2mm (7.01inch)
	Width	35 ± 1mm (1.38inch)
	Height	61 ± 1mm (2.40inch)
	Total Height	67 ± 1mm (2.64inch)
Approx. Weight		0.9kg (1.98lbs) ± 5%
Terminal type		T1
Internal resistance (Fully charged, 25°C)		Approx. 60mΩ
Capacity affected by temperature (20HR)	40°C	102%
	25°C	100%
	0°C	85%
	-15°C	65%
Self-discharge (25°C)	3 month	Remaining Capacity: 91%
	6 month	Remaining Capacity: 82%
	12 month	Remaining Capacity: 65%
Nominal operating temperature		25°C ± 3°C (77°F ± 5°F)
Operating temperature range	Discharge	-15°C ~ 50°C (5°F ~ 122°F)
	Charge	-10°C ~ 50°C (14°F ~ 122°F)
	Storage	-20°C ~ 50°C (-4°F ~ 122°F)
Float charging voltage(25°C)		13.60 to 13.80V Temperature compensation: -18mV/°C
Cyclic charging voltage(25°C)		14.50 to 14.90V Temperature compensation: -30mV/°C
Maximum charging current		0.69A
Terminal material		Copper
Maximum discharge current		34.5A(5 sec.)
Designed floating life(20°C)		3~5 years

Dimensions

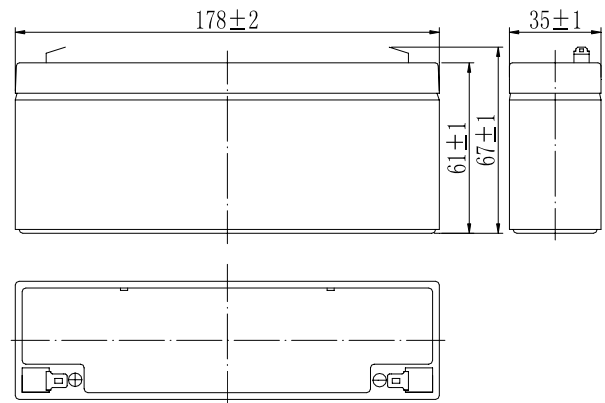

Terminal

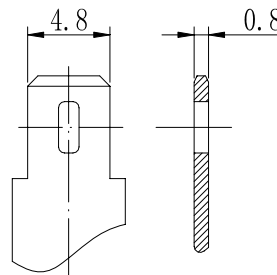

Terminal T1

- ◆ Absorbent glass mat technology;
- ◆ Recognized by UL & CE;
- ◆ ABS container.

Constant Current Discharge Characteristics (A, 25°C)

F.V/TIME	5min	10min	15min	30min	60min	2h	3h	4h	5h	10h	20h
9.60V	8.74	5.52	4.37	2.44	1.50	0.82	0.59	0.47	0.40	0.22	0.117
9.90V	8.48	5.35	4.27	2.39	1.47	0.81	0.58	0.47	0.40	0.22	0.116
10.2V	8.13	5.13	4.11	2.32	1.44	0.81	0.58	0.46	0.39	0.22	0.116
10.5V	7.78	4.91	3.97	2.26	1.41	0.79	0.58	0.46	0.39	0.21	0.115
10.8V	7.34	4.64	3.76	2.18	1.36	0.77	0.56	0.45	0.38	0.21	0.113

Constant Power Discharge Characteristics (Watt, 25°C)

F.V/TIME	5min	10min	15min	30min	60min	2h	3h	4h	5h	10h	20h
9.60V	97.5	62.3	49.8	27.9	17.3	9.56	6.97	5.59	4.76	2.61	1.40
9.90V	94.6	60.4	48.6	27.4	17.1	9.50	6.93	5.56	4.73	2.60	1.40
10.2V	90.7	57.9	46.8	26.5	16.6	9.42	6.88	5.52	4.70	2.58	1.39
10.5V	86.8	55.4	45.2	25.9	16.3	9.28	6.83	5.48	4.67	2.57	1.38
10.8V	81.9	52.3	42.8	24.9	15.8	9.04	6.63	5.31	4.53	2.52	1.35

Note: The above characteristics data can be obtained within three charge/discharge cycles.

Discharge Characteristics(25°C)

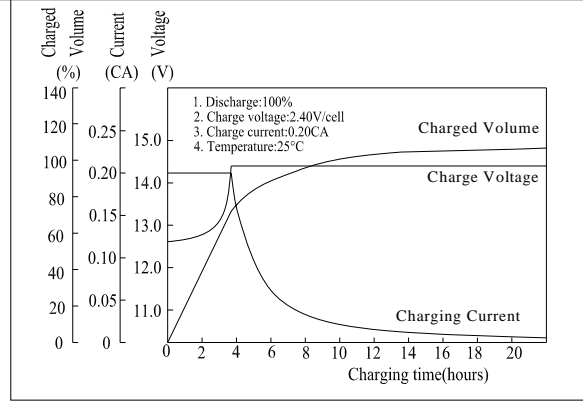
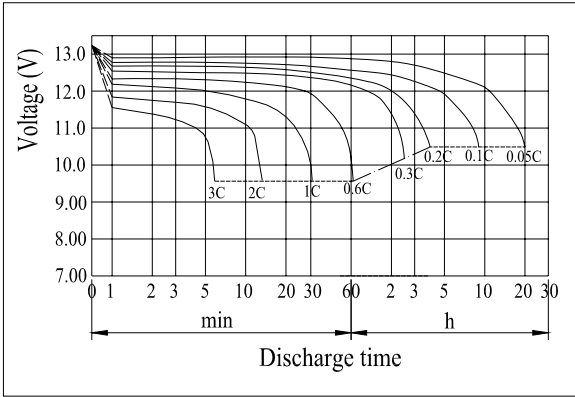

Effect of Temperature on Capacity

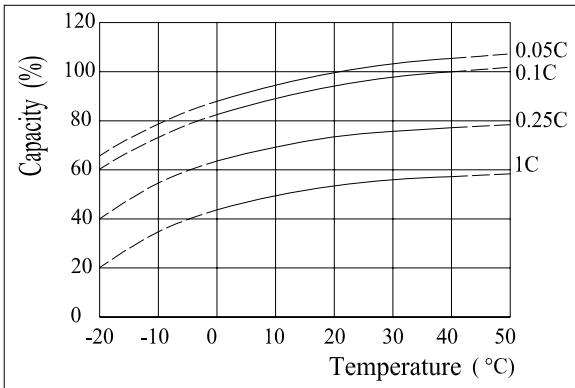

Self-discharge Characteristics

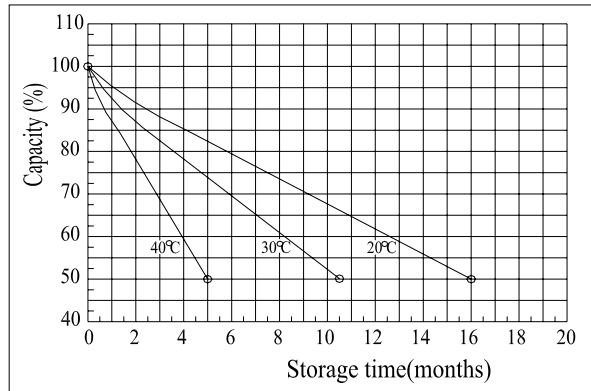

The Relationship for Open Circuit Voltage and Residual Capacity (25°C)

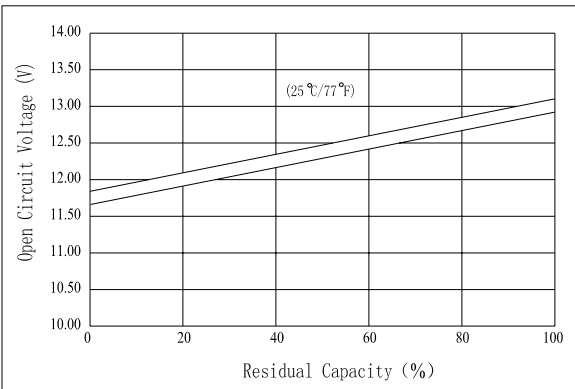

The Relationship for Charging Voltage and Temperature

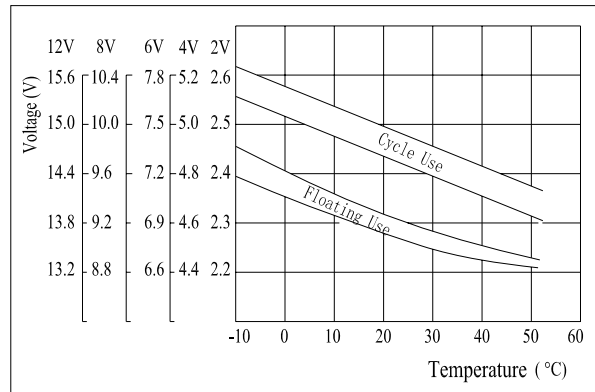

Floating Life on Temperature

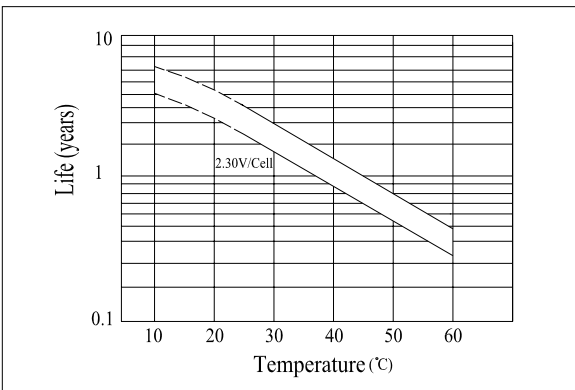

Cycle Life on D.O.D(25°C)

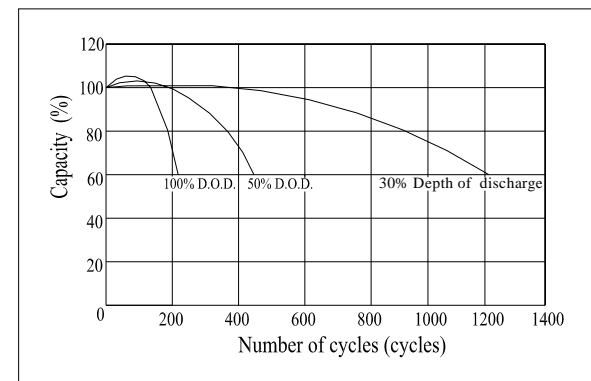

Charging Characteristics(25°C)